

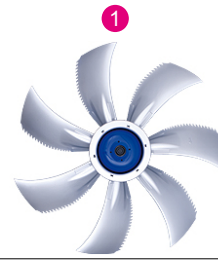

fan data

05.11.2024

version FANselect V 1.01 (241105), AMCA V 1.03 September, 2021
RLT V 1.00 Dezember, 2021 / 1.24.11.05 | 30813 | (user ZAFS20813)



type	FN063-ZID.DG.A7P2
article no.	179686 Portfolio STD-WW

technical data

motor		ECblue
Efficiency class		IE5
mains supply	-	3~ 400V 50Hz
ambient temperature, max. limit (t_r)	°C	60
efficiency grade η_{statA}	%	48,5
efficiency grade N_{actual} N_{target}		54,6 40
ErP-conformity		2015 EC controller integrated
grille influence		pressure side measured

fan data

fan speed (n) max. (n_{max})	1/min	- 1200
frequency (f_{DP}) (f_{max})	Hz	50 60
dimensions (w x h x d)	mm	683 x 683 x 196
product weight (m_{pr})	kg	15.5

PF-PF_50; Type:FN063-ZID; STol:+-10 %

FANselect



performance curve / acoustics

05.11.2024

Version FANselect V 1.01 (241105), AMCA V 1.03 September, 2021
RLT V 1.00 Dezember, 2021 / 1.24.11.05 | 30813 | (user ZAFS20813)

1 FN063-ZID.DG.A7P2

Measured in full nozzle with pressure side guard grille in air flow direction V in installation type A according to ISO5801

179686 | Portfolio STD-WW measurement density 1.18 [kg/m³]

air performance p_{sF}

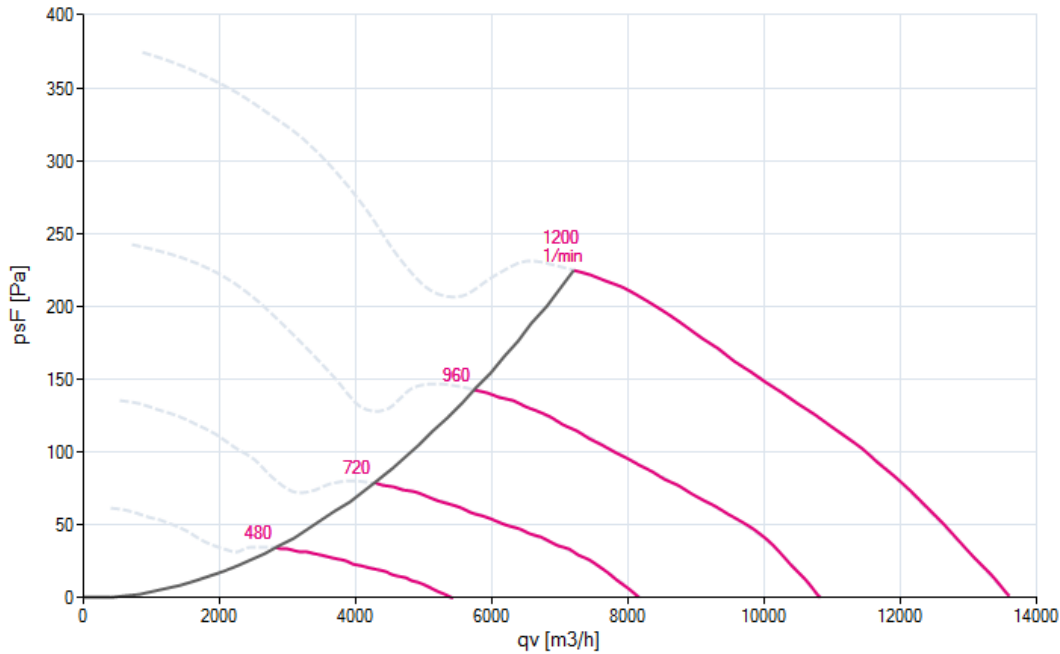

acoustics ($L_{w(A),5}$)

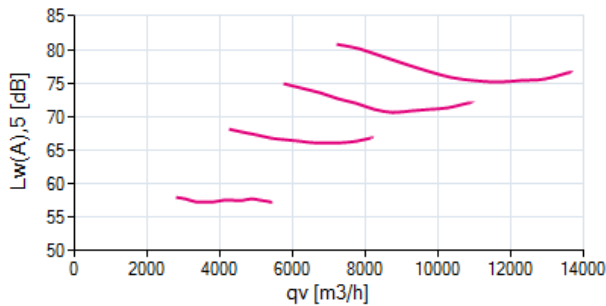

acoustics ($L_{w(A),6}$)

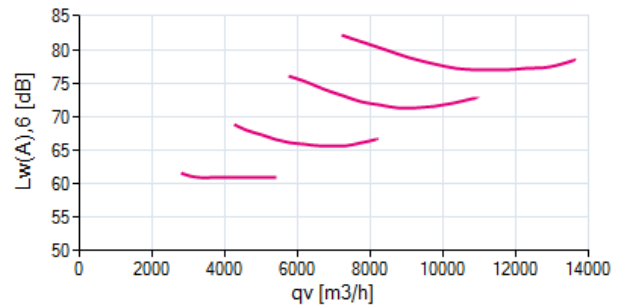

1 FN063-ZID.DG.A7P2

f [Hz]	sum	63	125	250	500	1000	2000	4000	8000
$L_{w(A),5}$	-	-	-	-	-	-	-	-	-
$L_{w,5}$	-	-	-	-	-	-	-	-	-

f [Hz]	sum	63	125	250	500	1000	2000	4000	8000
$L_{w(A),6}$	-	-	-	-	-	-	-	-	-
$L_{w,6}$	-	-	-	-	-	-	-	-	-

FANselect



efficiency grade / power input

05.11.2024

Version FANselect V 1.01 (241105), AMCA V 1.03 September, 2021
 RLT V 1.00 Dezember, 2021 / 1.24.11.05 | 30813 | (user ZAFS20813)

1

FN063-ZID.DG.A7P2

Measured in full nozzle with pressure side guard grille in air flow direction V in installation type A according to ISO5801

179686 | Portfolio STD-WW

measurement density 1.18 [kg/m³]

efficiency grade $\eta_{F,sys}$

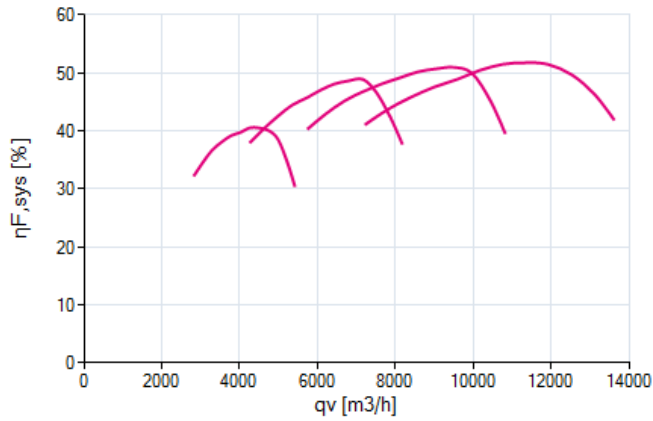

efficiency grade $\eta_{sF,sys}$

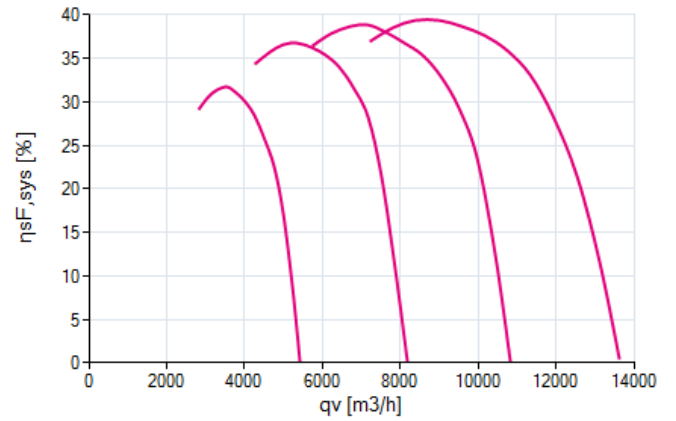

power input P_{sys}

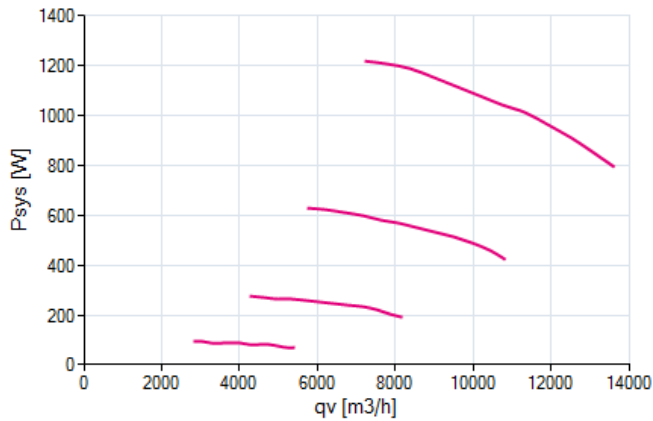



nominal values

05.11.2024

version FANselect V 1.01 (241105), AMCA V 1.03 September, 2021
RLT V 1.00 Dezember, 2021 / 1.24.11.05 | 30813 | (user ZAFS20813)

1



FN063-ZID.DG.A7P2

179686

3~ 380-480V 50Hz P1 1.25kW
 2.00-1.60A 1200/MIN 60°C
 3~ 380-480V 60Hz P1 1.25kW
 2.00-1.60A 1200/MIN 60°C
 IP55 THCL155

drawing

05.11.2024

version FANselect V 1.01 (241105), AMCA V 1.03 September, 2021
RLT V 1.00 Dezember, 2021 / 1.24.11.05 | 30813 | (user ZAFS20813)

1



FN063-ZID.DG.A7P2

179686

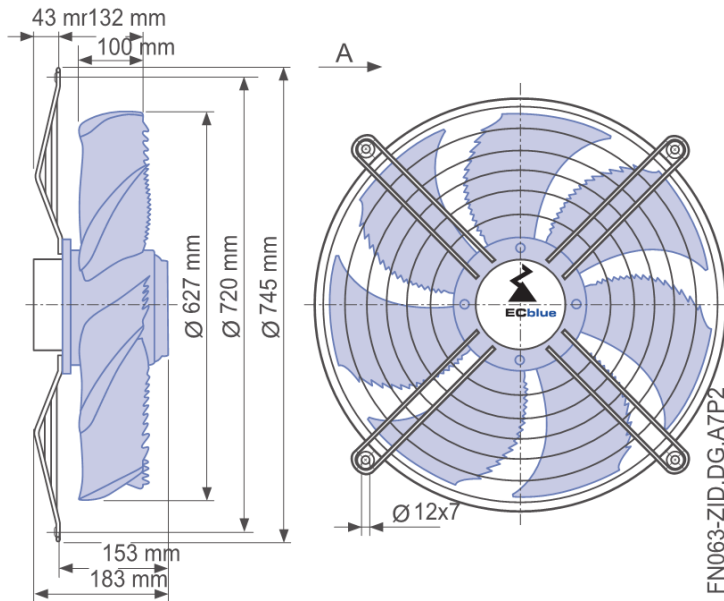

wiring diagram

05.11.2024

version FANselect V 1.01 (241105), AMCA V 1.03 September, 2021
RLT V 1.00 Dezember, 2021 / 1.24.11.05 | 30813 | (user ZAFS20813)

1



FN063-ZID.DG.A7P2

179686

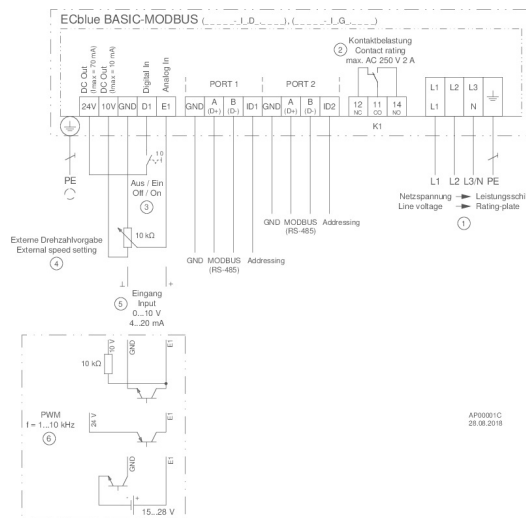



system components

05.11.2024

Version FANselect V 1.01 (241105), AMCA V 1.03 September, 2021
RLT V 1.00 Dezember, 2021 / 1.24.11.05 | 30813 | (user ZAFS20813)

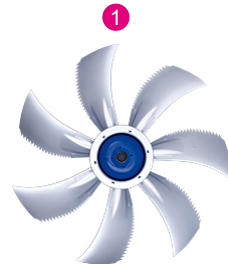

type	FN063-ZID.DG.A7P2
article no.	179686